

Plasma Lift - Vertical Up



A contemporary solution to audio visual storage, the Interfit Plasma Lift is designed to raise and lower your Plasma screen from custom built cabinetry using a structurally rigid lineal bearing system to make your Plasma screen safe, secure and out of sight when not in use.

With slimline design and fail-safe mechanism to protect the user, combined with its integrated door opening solution, the Interfit Plasma Lift provides a simple modular approach to what was once a complicated installation.

Available in 4 sizes with 2 door opening options, a universal mounting bracket suitable for most flat panel designs, the Interfit Plasma Lift should be your lifter of choice.

Low profile mechanism ... internal cabinet height = panel height + 25mm!

BENEFITS

- Low Line Design
- Fail-Safe Mechanism
- Simple, Single Trade Installation
- Adjustable Travel

APPLICATIONS

- Home Theatre
- Boardroom Presentation
- Educational Facilities

FEATURES

Description: Floor Mounted Vertical Lifting Devices for Flat Panel Monitors.

Construction: Powder coated aluminium frame & mechanism - utilising lineal bearing arms for lift.

Features: Integrated door opening solution - low cabinet requirements - Fall Arrester System.

Installation: Sits on own platform with back brace brackets for security.

Sizes: 4 sizes available.

Options: Fixed lid top bracket.



See page 19 for more information about the exclusive Connect Motor Control System.

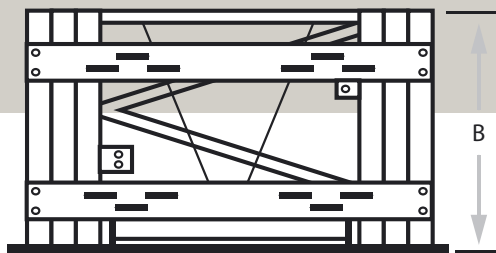
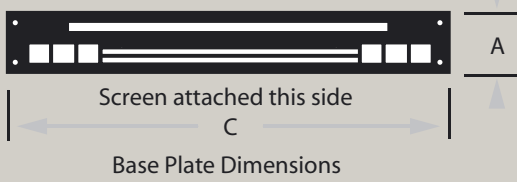

Front View (lowered)

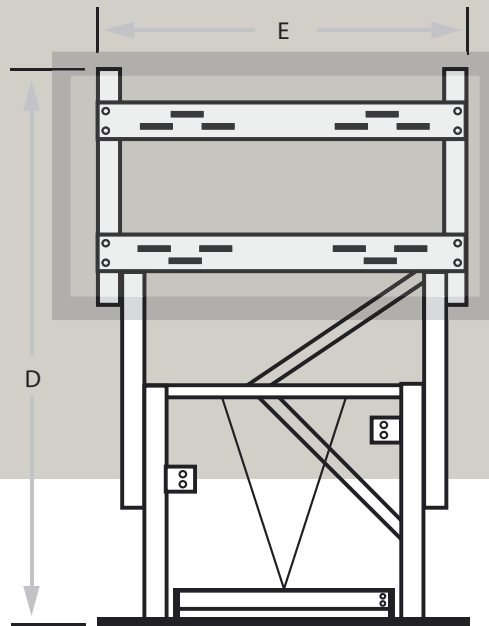

Front View (raised)

Item No	Unit Dimensions (mm)					Panel Size Guide (only)	Unit Weight	Lifting Capacity
	C	A	B	D	E			
1461000	830	100	600	1570	750	32" to 37" Diagonal	18kg	45kg
1461150	930	100	600	1470	850	40" to 42" Diagonal	20kg	55kg
1461300	1040	100	680	1710	960	42" to 50" Diagonal	25kg	85kg
1461450	1230	100	780	2005	1150	50" to 55" Diagonal	30kg	100kg

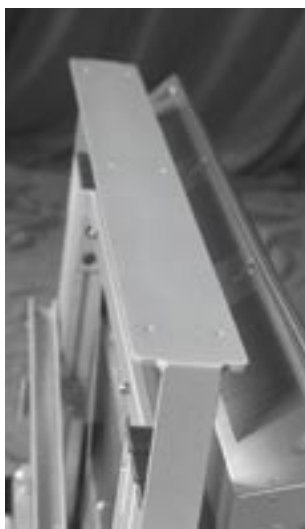

All Units come with an Integrated Cabinet Door Opening Solution or as an Optional Extra can be ordered with a Fixed Lid Top Bracket.



Full technical drawings and installation instructions can be found on our website.

Interfit

Plasma Lift -Vertical Down



A contemporary solution to audio visual storage, the Interfit Plasma Lift is designed to lower and raise your Plasma screen from the ceiling using a structurally rigid lineal bearing system to make your Plasma screen safe, secure and out of sight when not in use.

The Interfit Plasma Lift's slimline design and fail-safe mechanism protects the user, while its integrated door and ceiling cover edge strips provide a simple modular approach for easy, single trade installation.

Available in 5 sizes with adjustable travel and tilt facilities and a universal mounting bracket suitable for most flat panel designs. The Interfit Plasma Lift ... your lifter by choice.

Ultra smooth and stable mechanism with integrated door solution!

BENEFITS

- Modular Design
- Fail-Safe Mechanism
- Easy, Single Trade Installation
- Adjustable Travel & Tilt

APPLICATIONS

- Home Theatre
- Boardroom Presentation
- Educational Facilities

FEATURES

Description: Ceiling Mounted Vertical Lifting Devices for Flat Panel Monitors.

Construction: Powder coated aluminium frame & mechanism - utilising lineal bearing arms for lift.

Features: Integrated door opening solution with Ceiling Edge Cover Strips - Fall Arrester System.

Installation: Caged one piece unit, utilising nutcerts for 'L' Brackets or eyebolts for chain install.

Sizes: 5 sizes available.



See page 19 for more information
about the exclusive
Connect Motor Control System.

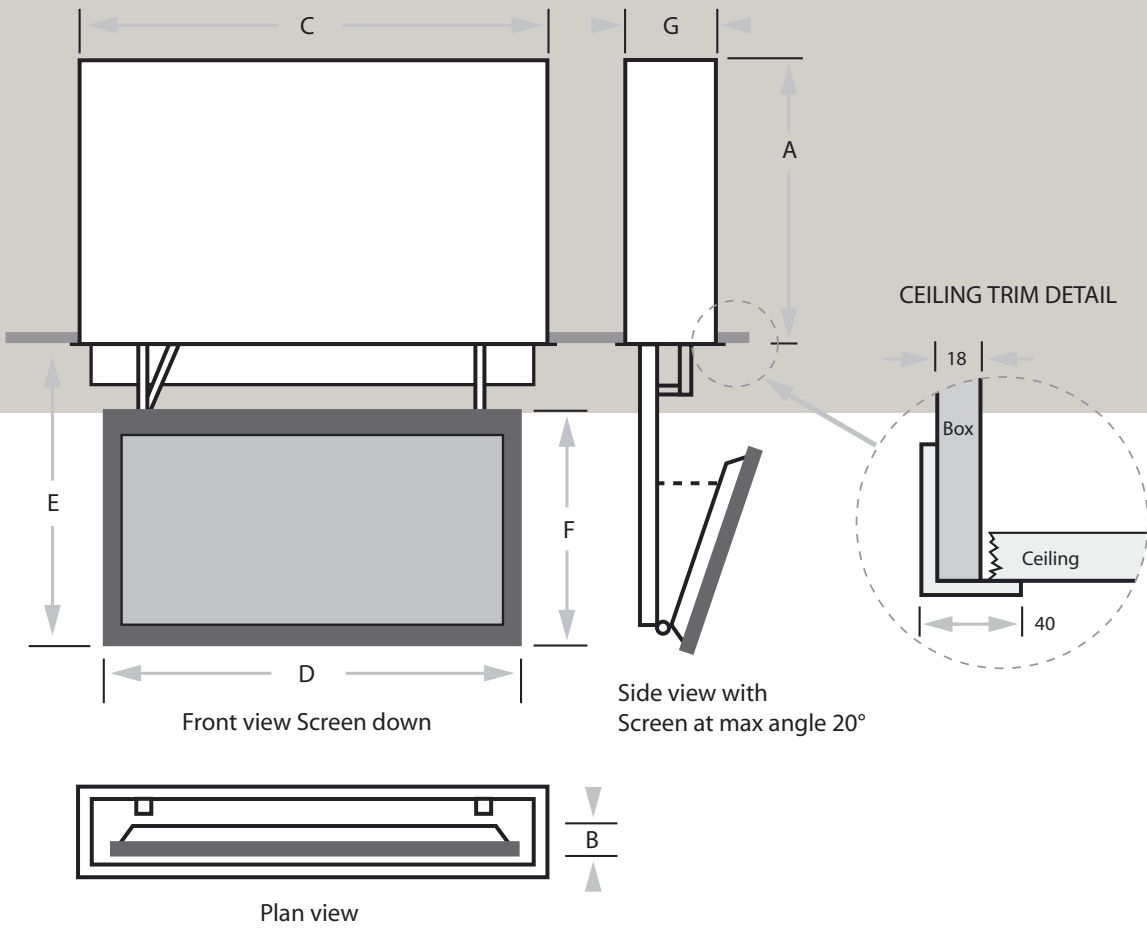

Item No	Unit Dimensions			Max Panel Dimensions			Travel	Panel Size Guide (only)	Unit Weight	Lifting Capacity
	C	G	A	D	B	F				
1471000	1110	290	960	1000	145	652	1140	32" to 37" Diagonal	65kg	60kg
1471150	1260	290	960	1150	145	760	1350	40" to 42" Diagonal	75kg	70kg
1471300	1410	290	1060	1300	145	860	1500	42" to 50" Diagonal	85kg	80kg
1471450	1560	290	1100	1450	145	900	1500	50" to 55" Diagonal	95kg	85kg
1471600	1710	290	1200	1600	145	1000	1500	55" plus Diagonal	105kg	90kg

Full technical drawings and installation instructions can be found on our website.



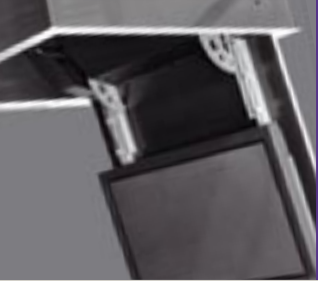

Interfit AV Plasma Lifter Swing Down



Not enough space to install a Plasma Lift vertically in the ceiling? Why not install it horizontally and watch it swing down into position ready for use!

Providing a unique solution to limited space situations, the Swing Down Interfit Plasma Screen Lifter is designed using a single integrated box design with ceiling edge cover strips and fitted MDF door for a simple, modular single trade installation.

Adjustable to swing up to 20 degrees past the vertical plane, the Swing Down Interfit Plasma Screen Lifter ensures Plasma visibility for the viewing audience from boardroom to bedroom. Interfit's featured gearbox fail-safe mechanism protects the installer and end users alike – don't depend upon a cable for your safety – use Interfit!

BENEFITS

- Mechanical Lifting Arms
- Fail-Safe Assured
- Simple Single Trade Installation

APPLICATIONS

- Home Theatre
- Boardroom Presentation
- Educational Facilities

PRODUCT FEATURES

Description: Horizontally Mounted Swing Down Lifting Devices for Flat Panel Monitors.

Construction: Aluminium & Steel Construction Utilising a Gearbox and Gas Strut Lever Arm System.

Features: Integrated door opening solution with Ceiling Edge Cover Strips.

Installation: One piece unit, utilising nutcerts for 'L' Brackets.

Sizes: 5 sizes available.



*See page 19 for more information
about the exclusive Connect Motor
Control System.*

**Gearbox mechanism provides smooth
operation and complete safety!**

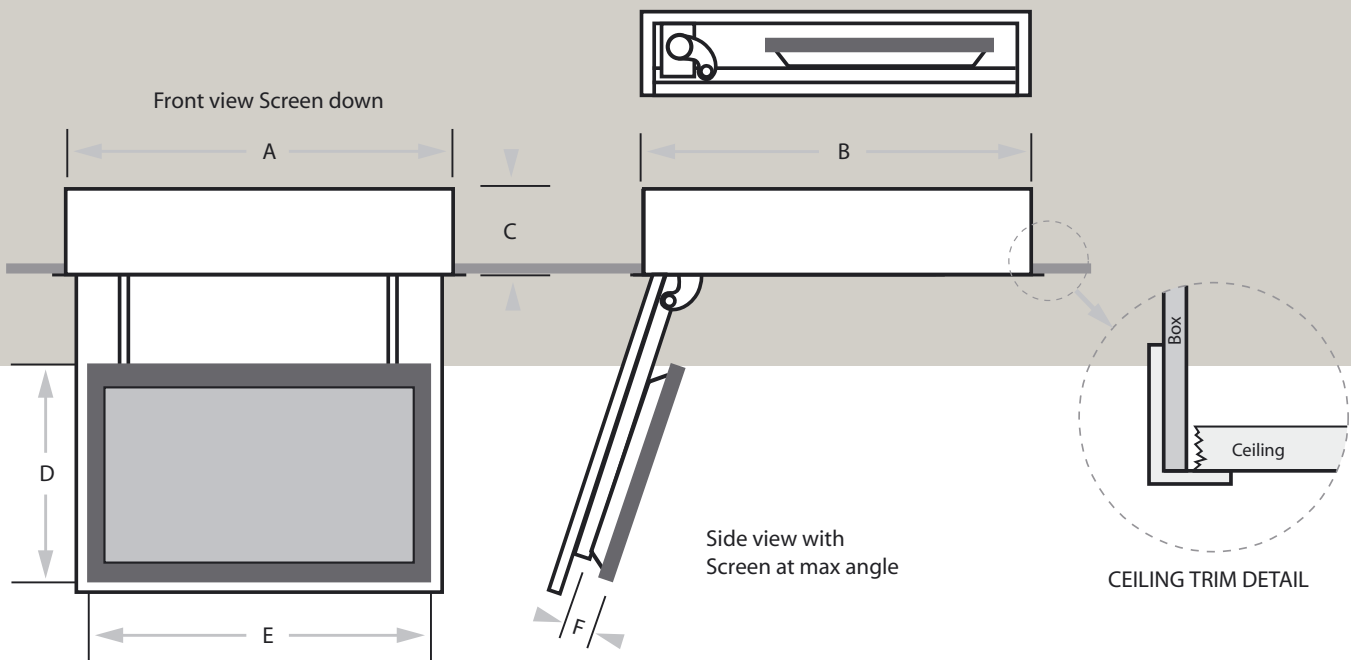

Item No	Unit Dimensions			Max Panel Dimensions			Panel Size Guide (only)	Unit	Lifting
	A	B	C	E	F	D		Weight	Capacity
1481000	1120	1150	310	1000	145	652	32" to 37" Diagonal	90kg	60kg
1481150	1270	1260	310	1150	145	760	40" to 42" Diagonal	100kg	70kg
1481300	1420	1360	310	1300	145	860	42" to 50" Diagonal	115kg	80kg
1481450	1570	1400	310	1450	145	900	50" to 55" Diagonal	130kg	85kg
1481600	1720	1500	310	1600	145	1000	55" plus Diagonal	145kg	90kg

Full technical drawings and installation instructions can be found on our website.

